

# **DELPHI GLOBAL CONTAINER LABEL REQUIREMENTS STANDARD**



**VERSION 5.3**

January 1, 2010

## Revision History

Release number	Date of Release/Update	Comments
3.2	April 2003	Added this revision history page. Added clarification to the sections concerning EDI PCI segments. Added SUBPACK label section. Added font size for Revision Level field (human readable).
4.0	October 2006	Added small container label requirements. Updated Paired parts label. Numerous changes made in order to more clarify requirements.
5.0	October 2007	Added rules pertaining to master labels and mixed pallets. Highlighted changed text. Clarified supplier number. Clarified requirement for Engineering change/Revision level. Updated division contacts.
5.1	April 2008	Correction of the location of Plant/Dock field information in the DELJIT.
5.2	December 2008	Correction of contacts phone numbers
5.3	January 2010	Increased scope of standard to Global (except Europe, which uses Odette standard) , added link to divisional contacts spreadsheet and link to Odette Standard.
5.3	November 10, 2011	Updated links to supplier portal, due to server change. Page 4. Removed broken links in table of contents page 3. JSC

The Delphi *Global Container Label Requirements Standard* contains specifications for Shipping container bar code labels for material shipped from external suppliers to all global Delphi locations, except Europe. Delphi Europe requires external suppliers to follow the Odette Standard. Please reference [Odette Global Transport Label](#) for the European Standard.

**Table of Contents:**

**Preface** .....

**A. Introduction** .....

**B. Normative References** .....

**C. Definitions** .....

**D. General Information** .....

**E. Container Label** .....

**F. Master Label** .....

**G. Mixed Load Label – Multiple Single Packs of Differing Parts** .....

**H. Dual or Paired Parts Label** .....

**I. Sub Pack Label** .....

**J. Placement** .....

**K. Quality Check** .....

**L. Packing List minimum requirements** .....

**Appendix** .....

- Appendix A: Label Approval Form
- Appendix B: Label Approval Checklist by Delphi Internal Usage
- Appendix C: Delphi North America Labeling Contact List by Each Division
- Appendix D: Suggested Label Placement

# Preface

The purpose of this document is to clarify Delphi's *required* packaging label format, give specific data formats and barcode symbology to our suppliers, and communicate the acceptable labeling standards expected from our trading partners. These specifications are needed to allow a Delphi prescribed supplier to become compliant with our label formats and placement requirements.

This is a living document with periodic updates as business processes change within Delphi and new technology emerges. All Delphi suppliers needing support for any Portal application must dial 1-877-7DELPHI. International callers dial: 1-915-774-6599.

Delphi Supplier Portal Link:

<http://delphi.covisint.com>

As an alternate, try

[https://portal.covisint.com/portal/public/\\_l=en/\\_ns:YTI5NHxjMHxkMHxiZGV0YWIsSWQ9MT0yOTQ\\_/tp/delphi?doc\\_id=a7031cbac6ffe1acc29877e9686b1ee0](https://portal.covisint.com/portal/public/_l=en/_ns:YTI5NHxjMHxkMHxiZGV0YWIsSWQ9MT0yOTQ_/tp/delphi?doc_id=a7031cbac6ffe1acc29877e9686b1ee0)

Audience:

- A. Direct suppliers of raw materials, subassemblies, or pre-manufactured goods used in the manufacturing process at a Delphi division without third party packaging partner.\*
- B. Third party packaging partner of a raw materials, subassemblies, or pre-manufactured goods used in the manufacturing process and shipping directly to a Delphi division.\*
- C. You are or plan to become a Delphi EDI (Electronic Data Interchange) trading partner.

\*Direct shippers to customers of Delphi may not need to comply with this specification. Specific customer labeling requirements take precedence over the Delphi requirements.

Delphi is comprised of multiple Divisions. Through involvement on the Delphi Label Data & Design Team, all divisions from North America are represented in the development of this standard.

Please note that the Delphi *Global Container Label Requirements Standard, Version 5.3*, supersedes all previous divisional container labeling requirements including Delphi's B10 requirement for North America, Version 2.0.

Delphi discourages placing data on its shipping/parts identification label other than described in this specification. However, if state, federal, or country laws are passed which require a supplier to include information such as health, safety, or environmental data be added to the label, the supplier should notify Delphi of the requirement.

# **A. Introduction**

## **A.1 Purpose**

The Delphi *Global Container Label Requirements Standard* provides written requirements for the printing and application of container labels. Suppliers, both internal and external, SHALL use the label formats detailed in this document when shipping to all Delphi facilities in North America.

The Delphi *Global Container Label Requirements Standard* is based on the General Motors 1724, released in October 1998. Since many of Delphi's suppliers had already converted to the GM1724, Delphi decided to minimize the impact of a new label to their suppliers by using a similar format, known as the Delphi B10 label. Label standards from other customers were also referenced to enhance this document.

In this document, the word '**SHALL**' indicates a requirement and the word '**SHOULD**' indicates a recommendation. These words followed by '**NOT**' will help emphasize the opposite of the statement.

In order to facilitate efficient and effective operations, Delphi's labeling requirements SHALL be followed exactly. If there is any concern in meeting these requirements, please contact your divisional representative, listed in Appendix C.

## **A.2 Hardware and Software**

Delphi recommends the use of bar-coding software and hardware, which allow flexibility in label generation.

Printers SHALL produce labels that meet AIAG specifications and tolerances. Thermal printers and laser printers are strongly recommended. Dot matrix printers SHALL NOT be used as bar-coded data can become skewed.

## **A.3 Sample Label Approval**

Suppliers SHALL submit sample labels to their divisional labeling representative indicated in Appendix C prior to changing their label format. Written approval will be sent from Delphi to the supplier once the label format is tested and passes. Please reference Appendix A for a copy of the approval sheet. Not all Delphi divisions or plants may use every field on the labels but your label printing application needs to be able to supporting printing them if required.

## **A.4 EDI certification**

Delphi continues to convert its operations over to the SAP ERP system architecture. For Delphi locations using SAP, suppliers SHALL be EDI certified as a matter of common business practice. For Delphi locations not using SAP, suppliers are strongly encouraged to become EDI certified. Please reference the *Delphi Electronic Data Interchange (EDI) Requirements Standard*.

## **B. Normative References**

AIAG Trading Partner Labels (B-10)  
ANSI Data Application Identifier Standard  
Delphi EDI Standards

## **C. Definitions**

### **Container Label**

A label used to identify the contents of the container.

### **Data Identifier**

A specified character string that defines the specific data that immediately follows as defined by ANSI MH10.8.2, Data Identifier Guideline

### **Electronic Data Interchange (EDI)**

The computer communication of data between trading partners.

### **Item**

A single part or material purchased, manufactured, and/or distributed.

### **Label**

A card, strip of paper, etc. marked and attached to an object to convey information.

### **Label Designer**

Person responsible for designing label format and determines the exact character heights corresponding to the eight text sizes.

### **Master Label**

A label used to identify and summarize the total contents of a multiple pack of a single part number within the same container. (i.e. pallet of boxes of same material number.)

### **Mixed Load Label**

A label used to identify the contents of a multiple pack of different part numbers. (i.e. pallet of boxes of differing material numbers.)

### **Shipping/Parts Identification Label**

A single pack, master or mixed load label used to identify the contents of shipping pack.

### **Sub Pack Label**

A single label applied to smaller packs within a larger container.

### **Standard Quantity Pack**

A single container, which contains the same quantity of like items.

### **Text Lines-per-block (LPB)**

The height of text characters is defined by using this unit of measure rather than inches, millimeters, or points.

### **DUNS number**

**DUNS stands for "Data Universal Numbering System." It is a unique nine-digit numbering system that is used to identify a business. For purpose of the shipping labels, it SHALL represent the suppliers ship from location.**

## **D. General Information**

### **D.1. Size and Material**

The label medium SHALL be white in color with black printing.

The size of the label medium SHALL be determined by a combination of the data requirements, size of the container and the printing technology used. For most shipping containers, the acceptable label size of 4.0 inches (101.6mm) high by 6.0 inches (152.4mm) wide should handle most conditions.

A smaller alternative sized label of 4.0 inches (101.6mm) wide by 2.0 inches (50.8) high SHALL also be used only when the container isn't large enough to accommodate the larger label. Your Delphi customer plant packaging engineer will help determine which label application is best for them.

Adhesive label medium types can be pressure sensitive or dry gummed as long as adherence to the package substrate is assured and application is wrinkle-free until received at final shipping destination.

## D.2. Types of Labels and Packaging

Four types of labels are required by Delphi depending on how material is packaged for shipment as described below:

The Container Label (AIAG B10) SHALL be used to identify a single pack containing the same part number. It is the most commonly used shipping/parts identification label.

A Master Label SHALL be used for containers, pallets, skids, etc., holding more than one single pack of the same part number per divisional requirements. Each individual package should still contain a container label within the outer package.

A Mixed Load Label and the Dual Parts Label are used for containers, pallets, skids, etc., holding more than one single pack of different part numbers. These labels may be required based on specific Delphi divisional requirements.

### D.2.1 Packaging

There are two types of packaging covered in this document; outer packages and inner packages. Inner packaging will utilize container labels while outer packages will utilize master labels. An outer package is any container that contains multiple packages of single materials. Inner packages are the smallest shippable packaged units of a material. Examples are pallets (outer packages) of boxes (inner container), bins (outer packages) of bags (inner packages), etc.

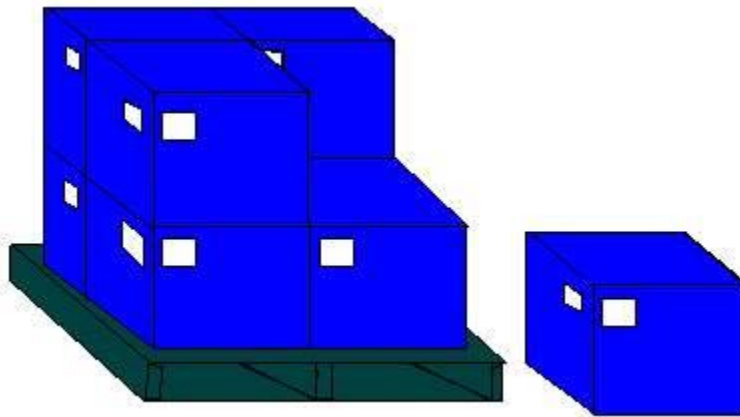

**Figure1 Group of packages with container labels and a single package labeled only with container labels. Pallet is not ready for shipment.**



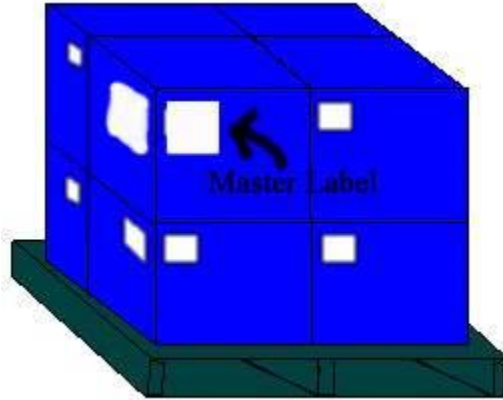

**Figure 2 Pallet with master labels attached on shrink wrap, ready for shipment. Notice the multiple container labels on each individual inner package.**

Two (2) labels should be attached to either inner or outer packages on adjacent sides or opposite sides depending on packaging. See section I for label placement.

**Two additional label types may be required by division for Mixed loaded material. These are described below:**

Mixed Load label format can be used for identification of materials of differing part numbers loaded within the confines of the same container or pallet. These can be of the same or differing quantities.

Dual or Paired Parts label format can be used for identification of materials which ship in pairs or opposites such as top and bottom, left and right, front and back. These SHALL be of the same exact quantity.

On smaller packaging where the lid of the container covers the complete lower portion of the container, it will also be necessary to apply an additional label to the inner end of the container so that the material can still be identified when the lid is discarded.

### **D.3 Bar Code Symbology**

For the 6.0 inch wide by 4.0 inch high label and in accordance with the current AIAG B10 Shipping Label Specs, the bar code symbology used SHALL be Code 39 and Code 128.

Because the Delphi part number could reach a maximum length of 18 characters and the physical space on the label for the Lot # field, Code 128 SHALL be utilized. Use of Code 128 allows for the proper quiet zone (see D.3.7).

For the smaller labels mentioned previously in D1, Code 128 SHALL be used for all bar coded fields.

### **D.3.1 Code Configuration**

The four characters (\$, /, +, %) SHALL NOT be used on the Shipping/Part Identification Label. Suppliers SHALL NOT include spaces in bar code fields unless Delphi passes the data to you with embedded spaces.

### **D.3.2 Check Digits**

For code 39 or code 128, the check digits SHALL NOT be added to the bar codes or human readable interpretation.

### **D.3.3 Code Density and Dimensions**

This standard requires that the bar code meets a minimum height and that the bars and spaces maintain specific sizes and ratios. Acceptable (100%) scanner read rates also require that quiet zones and gap widths be a specific size.

### **D.3.4 Bar code Height**

For the larger 6.0 x 4.0 inch labels, the bar height SHALL be a minimum of 0.5 inches (13mm) unless otherwise noted. For the smaller 4.0 x 2.0 inch labels, the bar height SHALL be a minimum of 0.25 inches (6mm).

### **D.3.5 Narrow Elements**

The bars and spaces in a symbol are called elements. For each bar code 39 symbol, the narrow element width (known as the X dimension) SHALL be within the range of 0.013 to 0.017 inches (0.33 to 0.43 mm).

### **D.3.6 Wide to Narrow Element Ratio**

The ratio for code 39 of the average width of the wide elements to the average width of the narrow elements SHALL be 3:1, with an allowable range of 2.8:1 to 3.2:1.

### **D.3.7 Quiet Zone**

For optimum scanning, a symbol's leading and trailing clear area known as the quiet zone SHALL be at least 0.25inches (6.4mm).

## **E. Container Label (Standard Label)**

The purpose of this label is packaging identification allowing for some scan-able fields for data collection purposes at its' final destination. This label is used as the smallest shippable packaging unit (inner package) used to ship a single material number.

### **E.1 Required Data Areas and Titles**

Shown are the required data fields for a container label:

- Delphi Part number
- Quantity
- Purchase Order number or Pull Signal Number/Kanban ID
- Serial number
- PLT/DOCK
- Engineering Change/Revision Level \*
- Manufacturing Date
- Part Description
- Supplier Ship from Duns number
- Supplier Location's Name
- Supplier Location's Address
- Country of Origin

\* Some Delphi locations may not use Engineering Change number information.

The 'Supplier Free Space' area is not exact. This can be differently proportioned, as long as the Supplier has enough space to apply all required fields.

### **E.2 Use of Data Identifiers**

A data identifier is one or more character that defines a general category type or specific use of bar coded data. The bar-coded field SHALL start with the data identifier and will identify the type of information encoded in that symbol. Care must be taken that the bar-coded data has the proper data identifier.

The data identifier SHALL be printed in human readable characters in parentheses under the title for the appropriate data area.

The data identifier SHALL NOT be included in the human readable interpretation of the bar code symbol.

All lengths specified in the following sections do not include the data identifier within the bar-coded fields.

The data identifiers listed below SHALL be used on Delphi labels:

<u>Data Identifier</u>	<u>Data Area</u>
K	Purchase Order Number
P	Part Number
Q	Quantity
V	Supplier Ship from Duns number
1T	Lot Number *
15K	Pull Signal Number\ Kanban ID
2P	Engineering Change/Revision Level *
3S	Serial Number – Standard Container Label
4S	Serial Number - Master Label
5S	Serial Number - Mixed Load Label

\* (Optional by Delphi business unit)

**Figure 3: Data Identifier Table**

Using additional bar code symbols on shipping packages is discouraged but may be appropriate in certain circumstances.

### E.3 Text Lines-Per-Block

The height of text characters is defined by using a unit of measure called Lines-Per-Block (LPB), rather than inches, millimeters or points. This enables the printer of the label to determine the actual height and font of text for a given LPB.

Eight sizes may be specified for text, ranging from one to eight Lines-Per-Block (LPB). The exact character heights corresponding to the eight text sizes SHALL be chosen by the label designer based on the capabilities of the printing process.

Labelers SHALL choose a single height for each of the eight sizes so that clear distinctions SHALL be evident between text sizes. Table below shows suggested point, inch, and metric sizes.

Generally speaking, you should try to make the human readable characters as large as possible to fit the given space keeping mind the maximum number of characters a field would have to represent. Fields SHALL NOT at any time overlap. You should avoid printing characters so high and narrow that they are difficult to read.

**Lines-Per-Block (LPB) Calculation**

<b>Lines Per Block</b>	<b>Max. Characters Per Line</b>	<b>Point</b>	<b>Inches</b>	<b>MM</b>
1 LPB	8	64	0.90	22.0
2 LPB	18	32	0.40	11.0
3 LPB	28	20	0.25	7.0
4 LPB	34	16	0.20	5.0
5 LPB	42	12	0.15	4.0
6 LPB	48	10	0.12	3.0
7 LPB	59	8	0.10	2.0
8 LPB	68	6	0.08	1.5

**Figure 4:Text Conversion Table**

*Note: Based on label width of 6.0 inches and block height of 1 inch, specific font size will depend on the capability of the suppliers' printer and software*

## E.4 Data Area Characteristics (Container Label)



Figure 5 Container Label Standard Sample

All lengths specified in the following sections do not include the data identifier within the bar-coded fields.

### E.4.1 Top Block Left - PART # CUST (P)

The part number SHALL be the Delphi part number.

The Delphi part number has a maximum length of eighteen (18) alphanumeric characters.

The human readable part number characters SHALL be bold and a minimum 2 LPB high.

The bar code symbol for the part number SHALL be directly below the human readable characters, SHALL be a minimum of 2 LBP high, and SHALL contain the data identifier (P) at the beginning of the bar code.

## **E.4.2 Top Block Right - QUANTITY (Q)**

The maximum length for the quantity field is six (6) numeric characters. The human readable quantity characters SHALL be bold and a minimum of 2 LPB high. The bar code symbol for the quantity SHALL be printed directly above the human readable characters, SHALL be a minimum of 2 LBP high, and SHALL contain the data identifier (Q). The field data SHALL not start with zero (0) in the human readable nor should the data following the data identifier in the bar code be zero. The unit of measure SHALL appear in human-readable form printed after the human readable of the quantity field with a maximum length of 3 characters and be a minimum of 6 LPB high. Unit of measure is assumed to be PC for pieces. The Unit of measure for other types of commodities will be transmitted to the supplier in the DELFOR or DELJIT EDI.

## **E.4.3 2<sup>nd</sup> Block Left - KANBAN (15K) or P.O. (K)**

This section of data varies by Delphi facility. In the case of Kanban Number (also known as Pull Signal) if included in EDI transmission to supplier, the Kanban Number and the corresponding bar code with the correct field title and data identifier, should be in this area. If the Kanban Number is not provided to the supplier, the Purchase Order number assigned by Delphi should be in this area, again with the correct field title and data identifier.

\* The default will be the Purchase Order number assigned by Delphi.

This field has a maximum length of twelve (12) alphanumeric characters, the human readable characters SHALL be bold and a minimum 2 LPB high. The bar code symbol for this item SHALL be directly below the human readable characters, SHALL be a minimum of 2 LBP high, and SHALL contain the data identifier of K for Purchase Order Number or 15K for Kanban Number. For Kanban info, use KANBAN (15K) for box title. For Purchase Order info, use P.O. (K). It may be necessary to use Code 128 for the bar code field if your Delphi customer plant has longer data to be represented.

## **E.4.4 2<sup>nd</sup> Block Right – REV. LVL (2P) and DLOC\***

The human readable Revision Level, also known as Engineering Change Number SHALL be a minimum of 5 LPB in height. The bar code symbol for the revision level SHALL be directly after the human readable characters and SHALL contain the data identifier of 2P at the beginning of the bar code and SHALL be 3 LPB in height.. The maximum field length SHALL be three (3) characters alphanumeric. Some Delphi locations may not use Engineering Change number information.

The DLOC information indicates Delivery Location where the material will be stored internally at a Delphi division. The maximum length should be eight (8) characters. The human readable text of DLOC SHALL be bold and a minimum 3 LPB high. This data is typically from the EDI segment PCI 11Z.

\*DLOC may be optional for some divisions.

#### **E.4.5 3<sup>rd</sup> Block Left --- SERIAL # (3S)**

Each shipping container or pack SHALL have a unique number called a serial number. This number is assigned by the supplier, not Delphi, and does not necessarily need to be in sequential order. This unique number helps link the bar code data on the labels to EDI for trace-ability. The serial number SHALL NOT be repeated to Delphi on another label within a twelve-month period.

The serial number has a maximum length of nine (9) alphanumeric characters + Data Identifier (3S)

The human readable serial number characters SHALL be bold and a minimum 2 LPB high.

The bar code symbol for the serial number SHALL be directly below the human readable characters, SHALL be a minimum of 2 LPB high.

#### **E.4.6 3<sup>rd</sup> Block Right -- PLT/DOCK/LOT NUMBER/EDI SEGMENTS**

Line1: It indicates Plant and Dock designation. The data SHALL be bold and a minimum 3 LPB high, with a maximum length of 7 characters. The data comes from the LOC+11 segment.

LOT NO. is a supplier assigned lot control number (when and if needed). Format is at the supplier's discretion. If used, the human readable SHALL be a minimum of 5 LPB high, with a maximum length of ten (10) characters. The barcode symbology used SHALL be code 128 and be 4 LPB in height with a data identifier of 1T preceding the data. The human readable should be directly below the barcode. The title LOT NO.(1T) should precede the human readable.

Lines 2-4 SHALL be used by EDI Certified suppliers. Data requirements will vary by division. Suppliers not EDI certified should try to populate this data as accurately as possible. A heading on each used line denoting what is represented in the data element SHALL be used and SHALL be a minimum of 7 LPB in size and not more than 12 (twelve) characters in length. The last character of the heading should be a colon (:).

Line 2: If used, the data SHALL be a minimum of 5 LPB high, with a maximum length of 30 (thirty) characters. The data comes from the EDI PCI 13Z segment and its title SHALL be STORAGE BIN:

Line 3: If used, the data SHALL be a minimum of 5 LPB high, with a maximum length of 30 (thirty) characters. The data comes from the EDI PCI 14Z segment and its title SHALL be PLANT NAME:

Line 4: If used, the data SHALL be a minimum of 5 LPB high, with a maximum length of 30 (thirty) characters. The data comes from the EDI PCI 15Z segment and its title SHALL be PLANT CITY:



#### **E.4.7 4<sup>th</sup> Block Left – SUPPLIER FREE SPACE**

Population of this block is left to the discretion of the supplier.

#### **E.4.8 4<sup>th</sup> Block Right – Part and Supplier Information**

##### **Part Description, Supplier ship from Duns number, Supplier Name, Supplier City, State, Zip, Country of Origin, and Manufacture Date**

Supplier Ship from DUNS number field as provided by Delphi. The bar code field has a maximum length of twelve (12) alphanumeric characters + Data Identifier of "V". The human readable characters SHALL appear below the bar code and be bolded and a minimum 4 LPB high. The title and data identifier symbol for the Supplier Ship from Duns number field SHALL be directly to the left of the human readable characters.

Part Description has a maximum length of forty (40) characters, and SHALL be bold and a minimum 7 LPB high with the heading "DESC." at a minimum of 7 LPB. If you are EDI Certified, the part description of your customers PCI 17Z segment should appear here. If you are not certified, it should represent the part description your customer dictates.

MFG. DATE SHALL be minimum height of 7 LPB high, and formatted as MM/DD/YYYY with the heading "MFG. DATE:" at a minimum of 7 LPB.

Supplier Name SHALL be a minimum of 6 LPB high, with a maximum length of thirty six (36) characters. Supplier Street SHALL be a minimum of 7 LPB high, with a maximum length of thirty six (36) characters. Supplier City, State, Postal code and Country of Origin SHALL be on one line and be a minimum of 7 LPB high, with a maximum length of fifty (50) characters. The characters "MADE IN:" should appear before the country name.



## **F. Master Label**

A master label SHALL be used to identify the total contents of a multiple pack load of the same part number. If the multiple common item load is in a closed container, the container SHALL bear a label identifying the receiving facility and delivery location. Each pack of the multiple pack SHALL be identified with a single pack label, except shipping parts & service support material, or unless otherwise instructed in the Delphi purchase order.

Additional master label requirements can also be found in section G which talks of Mixed loads.

### **F.1 Required Data Elements**

Shown are the required data fields for a Master Load label:

- Delphi Part number
- Quantity
- Label Type
- Serial number
- Ship Date
- PLT/DOCK
- Part Description
- Supplier Ship from DUNS number
- Supplier Location's Name
- Supplier Location's Address
- Country of Origin

### **F.2 Use of Data Identifiers**

(Click to see section E.2)

### **F3. Text Lines-Per-Block**

(Click to see section E.3)

## F4. Data Area Characteristics (Master Label)

<b>MASTER LOAD</b>	
PART #: :CUST(P) <b>1234ABCD1234ABCD01</b> 	QUANTITY: (Q) <b>123456</b> XXX
SUPPLIER: (V) <b>123456789012</b> 	DLOC <b>12345678</b>
SERIAL #: (4S) <b>123456789</b> 	PLT./DOCK <b>1234567</b> ??????????? 12345678901234567890 ??????????? 12345678901234567890 ??????????? 12345678901234567890
<b>Supplier Free Space</b>	SHIP DATE: <b>07/26/2002</b> DESC: 1234567890123456789012345 123456789012345678901234567890 12345678901234567890 12 1234567 1234567890 MADE IN:

Figure 6: Master Load Label format

### F.4.1 Top Block Left – PART # CUST (P)

The phrase “MASTER LABEL” SHALL be printed in inverse above the human readable Delphi part number and SHALL be a minimum height of 4 LPB. The part number SHALL be the Delphi part number. The Delphi part number has a maximum length of eighteen (18) alphanumeric Characters. The human readable part number characters SHALL be bold and a minimum 3 LPB high. The bar code symbol for the part number SHALL be directly below the human readable characters, SHALL be a minimum of 2 LPB high, and SHALL contain the data identifier (P) at the beginning of the bar code.

### F.4.2 Top Block Right – QUANTITY (Q)

The maximum length for the quantity field is six (6) numeric characters. The human readable quantity characters SHALL be bold and a minimum of 2 LPB high. The bar code symbol for the quantity SHALL be printed directly above the human readable characters, SHALL be a minimum of 2 LBP high, and SHALL contain the data identifier (Q). The field data SHALL not start with zero (0) in the human readable nor should the data following the data identifier in the bar code be zero. The unit of measure SHALL appear in human-readable form printed after the human readable of the quantity field with a maximum length of 3 characters and be a minimum of 6 LPB high. Unit of measure is assumed to be PC for pieces. The Unit of measure for other types of commodities will be transmitted to the supplier in the DELFOR or DELJIT EDI.

### **F.4.3 2<sup>nd</sup> Block Left – SUPPLIER (V)**

Supplier Ship from DUNS number field as provided by Delphi. The bar code field has a maximum length of twelve (12) alphanumeric characters + Data Identifier of "V". The human readable characters SHALL appear above the bar code and be bold and a minimum 2 LPB high. The title and data identifier symbol for the Supplier Ship from Duns number field SHALL be directly to the left of the human readable characters.

### **F.4.4 2<sup>nd</sup> Block Right - DLOC**

The DLOC information indicates Delivery Location where the material will be stored internally at a Delphi division. The maximum length is limited to 8 characters. The text of DLOC SHALL be bold and a minimum 2 LPB high.

### **F.4.5 3<sup>rd</sup> Block Left – SERIAL (4S)**

Each shipping container or pack SHALL have a unique number called a serial number. This number is assigned by the supplier, not Delphi, and does not necessarily need to be in sequential order. This unique number helps link the bar code data on the labels to EDI for trace-ability. The serial number SHALL NOT be repeated to Delphi on another label within a twelve-month period. The serial number has a maximum length of nine (9) alphanumeric characters + Data Identifier (4S). The human readable serial number characters SHALL be bold and a minimum 2 LPB high. The bar code symbol for the serial number SHALL be directly below the human readable characters, SHALL be a minimum of 2 LBP high.

### **F.4.6 3<sup>rd</sup> Block Right - PLT/DOCK and shipping information**

Line1: It indicates Plant and Dock designation. The data SHALL be bold and a minimum 2 LPB high, with a maximum length of 7 characters. The data comes from the EDI LOC+11 segment.

Lines 2-4 SHALL be used by EDI Certified suppliers. Data will vary by division. Suppliers not EDI certified should try to populate this data as accurately as possible. A heading on each used line denoting what is represented in the data element SHALL be used and SHALL be a minimum of 7 LPB in size and not more than twelve (12) characters in length. The last character of the heading should be a colon (:).

Line 2: If used, the data SHALL be a minimum of 5 LPB high, with a maximum length of thirty (30) characters. The data comes from the EDI PCI 13Z segment and its title SHALL be STORAGE BIN:.

Line 3: If used, the data SHALL be a minimum of 5 LPB high, with a maximum length of thirty (30) characters. The data comes from the EDI PCI 14Z segment and its title SHALL be PLANT NAME:

Line 4: If used, the data SHALL be a minimum of 5 LPB high, with a maximum length of thirty (30) characters. The data comes from the EDI PCI 15Z segment and its title SHALL be PLANT CITY:.

### F.4.7 4<sup>th</sup> Block Left - Supplier Free Space

Population of this block is left to the discretion of the supplier.

### F.4.8 4<sup>th</sup> Block Right - Part and supplier information block

Contains: Ship Date, Part Description, Supplier Name, Supplier City, State, Zip, and Country of Origin.

Ship Date SHALL be the date the material ships from the suppliers location, SHALL be a minimum of 6 LPB, and in the format MM/DD/YYYY. It SHALL also be preceded by the heading "SHIP DATE:" at a minimum of 7 LPB.

The part description has a maximum length of forty (40) characters, and SHALL be bold and a minimum 5 LPB high with the heading "DESC.". If you are a EDI certified supplier, the part description from your customers PCI 17Z segment should appear here. If you are not certified, it should represent the part description your customer dictates.

Supplier Name SHALL be a minimum of 4 LPB high, with a maximum length of thirty six (36) characters. Supplier Street SHALL be a minimum of 7 LPB in height with a maximum of thirty six (36) characters. Supplier City, State, Postal code and Country of Origin SHALL be on one line and be a minimum of 7 LPB high, with a maximum length of fifty (50) characters. The characters "MADE IN:" should appear before the country name.

### F.4.9 Alternate 4.0 inch wide x 2.0 inch high Master label

There is no supplier free space on this label



Your Delphi packaging engineer will help you in determining which containers the above sized label is to be used for.

## G. Mixed Load Label –Multiple Single Packs of Differing Parts

The mixing of containers on a single skid/pallet destined for different plants or delivery docks SHALL NOT be allowed.

The Mixed load label SHALL be used to identify a load of multiple single packs of different part numbers. The Mixed load label SHALL appear on two adjacent sides of the pallet load. Additionally, the following rules **SHOULD** also be followed:

For a mixed part number skid/pallet, a MASTER label for each part number **SHOULD** be required. A Master label of each individual part **SHOULD** be applied on one side of the pallet where each can be scanned easily. When the pack is broken apart, the labels are discarded. See example below

1. Individual Master labels
2. Mixed label
3. Container label
4. Cardboard placard or similar where Master labels are applied. As an alternative, labels can be neatly applied to the shrink wrap in a way that bar code fields can be scanned.

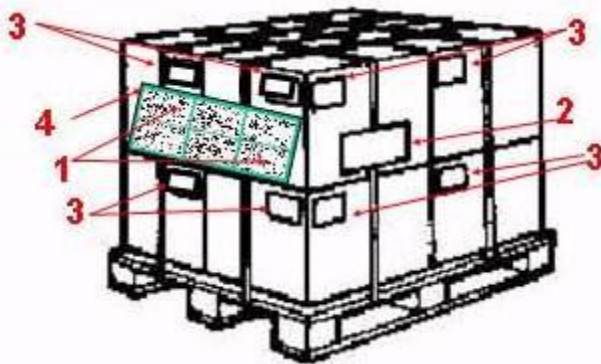

**MULTIPLE PLANT LOCATIONS ARE NOT ALLOWED ON A SINGLE SKID OR PALLET.**

### G.1 Required Data Elements

Shown below are the required the data areas for the Mixed Load Label:

- Label Type
- Supplier Ship from DUNS number
- Customer Name
- Customer Street Address, City, State and Postal Code
- Serial number
- Plant/Dock
- Ship Date
- Supplier Location's Name
- Supplier Location's Address

**G.2 Use of Data Identifiers**  
 (Click to see section E.2)

**G3. Text Lines-Per-Block**  
 (Click to see section E.3)

**G4. Data Area Characteristics (Mixed Load Label)**



Figure 7: Mixed Load Label format

**G.4.1 Top2 Blocks - Label type**

This section is reserved for a 1 LPB inverse printing of the label type. 'MIXED LOAD' should be printed in this section.

**G4.2 2<sup>nd</sup> Block Left – SUPPLIER (V)**

Supplier Ship from DUNS number field as provided by Delphi. The bar code field has a maximum length of twelve (12) alphanumeric characters + Data Identifier of "V". The human readable characters SHALL appear above the bar code and be bold and a minimum 2 LPB high. The title and data identifier symbol for the Supplier Ship from Duns number field SHALL be directly to the left of the human readable characters.



### **G.4.3 2<sup>nd</sup> Block Right - Customer Shipping information**

Line 1: Delphi plant name with a minimum height of 4 LPB minimum, maximum of thirty six (36) characters alphanumeric. Line 2: Delphi plant street address, minimum height of 4 LPB, maximum of thirty six (35) characters alphanumeric. Line 3: Delphi plant city, state and postal code on one line, a minimum height of 4 LPB, maximum of thirty six (35) characters alphanumeric.

### **G.4.4 3<sup>rd</sup> Block Left – SERIAL # (5S)**

Each shipping container or pack SHALL have a unique number called a serial number. This number is assigned by the supplier, not Delphi, and does not necessarily need to be in sequential order. This unique number helps link the bar code data on the labels to EDI for trace-ability. The serial number SHALL NOT be repeated to Delphi on another label within a twelve-month period. The serial number has a maximum length of nine (9) alphanumeric characters + Data Identifier (5S). The human readable serial number characters SHALL be bold and a minimum 2 LPB high. The bar code symbol for the serial number SHALL be directly below the human readable characters, SHALL be a minimum HEIGHT of 7 LBP.

### **G.4.5 3<sup>rd</sup> Block Right - PLT/DOCK**

Line1: It indicates Plant and Dock designation. The data SHALL be bold and a minimum 2 LPB high, with a maximum length of 7 characters. The data comes from the EDI LOC+11 segment.

Lines 2-4 SHALL be used by EDI Certified suppliers. Data will vary by division. Suppliers not EDI certified should try to populate this data as accurately as possible. A heading on each used line denoting what is represented in the data element SHALL be used and SHALL be a minimum of 7 LPB in size and not more than twelve (12) characters in length. The last character of the heading should be a colon (:).

Line 2: If used, the data SHALL be a minimum of 5 LPB high, with a maximum length of thirty (30) characters. The data comes from the EDI PCI 13Z segment and its title SHALL be STORAGE BIN: and be a minimum of 5 LPB in height.

Line3: If used, the data SHALL be a minimum of 5 LPB high, with a maximum length of thirty (30) characters. The data comes from the EDI PCI 14Z segment and its title SHALL be PLANT NAME: and be a minimum of 7 LPB in height.

Line 4: If used, the data SHALL be a minimum of 5 LPB high, with a maximum length of thirty (30) characters. The data comes from the EDI PCI 15Z segment and its title SHALL be PLANT CITY: and be a minimum of 7 LPB in height.

### **G.4.6 4<sup>th</sup> Block Left - Supplier Free Space**

Population of this block is left to the discretion of the supplier.

## G.4.7 4<sup>th</sup> Block Right - Supplier information block

### Contains: Supplier Name, Supplier City, State, Zip, and Ship Date

Ship Date SHALL be the date the material ships from the supplier's location, SHALL be a minimum of 4 LPB, and in the format MM/DD/YYYY. It SHALL also be preceded by the heading "SHIP DATE" at a minimum of 7 LPB.

Supplier Name SHALL be a minimum of 4 LPB high, with a maximum length of thirty six (36) characters. Supplier Street SHALL be a minimum of 4 LPB in height with a maximum of thirty five (35) characters. Supplier City, State, Postal code and Country of Origin SHALL be on one line and be a minimum of 4 LPB high, with a maximum length of forty (40) characters. The characters "MADE IN:" should appear before the country name.

## G.4.8 Alternate 4.0 inch wide x 2.0 inch high Mixed load label

There is no supplier free space on this smaller label

<b>MIXED LOAD</b>		
	PLT/DOCK <b>1234567</b>	SHIP DATE <b>08/31/2006</b>
SUPPLIER (M) <b>1234ABCD0</b>	XXXXXXXXXXXX 123456789012345678901234567890 XXXXXXXXXXXX 123456789012345678901234567890	
SERIAL (SS) <b>1234ABCD0</b>	12345678901234567890123456789012345678 12345678901234567890123456789012345678 12345678901234567890123456789012345678	

Your Delphi packaging engineer will help you in determining which containers the above sized label is to be used for.

## H. Dual Parts Label

The requirement of a Dual Part Label Format is optional by division. When the dual part label is required, the specifications within this document SHALL be followed.

Some materials may be shipped as left hand and right hand, top and bottom or other combinations which create an environment of pairs. These are known to Delphi as dual parts or paired parts. These parts also have a specific label format that SHALL be used for materials shipping in this manner based on divisional requirements. The goods shipped SHALL be of the same exact quantity.

## H.1 Required Data Elements

Shown below is a sample container label with the data areas required:

- Label Type
- Part numbers (2)
- Quantity
- Serial number
- Plant Dock
- Ship Date
- Supplier Ship from DUNS number
- Supplier Location's Name
- Supplier Location's Address

## H.2 Use of Data Identifiers

[Refer to section E.2](#)

## H.3. Text Lines-Per-Block

[Refer to section E.3](#)

## H4. Data Area Characteristics (Dual or Paired Parts Label)

<b>PAIRED PARTS</b>	
PART NUMBERS <b>123456789012345678</b> <b>123456789012345678</b>	 QUANTITY (Q) <b>123456</b> SETS
SUPPLIER (V) <b>123456789012</b> 	DLOC <b>12345678</b>
SERIAL NO (SS) <b>123456789</b> 	PLT./DOCK <b>1234567</b> STORAGE BIN: 123456789012345678901234567890 PLANT NAME: 123456789012345678901234567890 PLANT CITY: 123456789012345678901234567890
DESCRIPTION PART #1 <b>123456789012345678901234567890</b> <b>123456789012345678901234567890</b> PART #2 <b>123456789012345678901234567890</b> <b>123456789012345678901234567890</b>	SHIP DATE: <b>1234567890</b> <b>123456789012345678901234567890123456</b> 12345678901234567890123456789012345 12345678901234567890123456789012345 12345678901234567890

Figure 8: Dual or Paired parts label format

#### **H.4.1 Top Block Left - Part Numbers**

The two part numbers SHALL be the Delphi part numbers. The label SHALL contain only 2 human readable only parts which are considered “Paired” parts in that they may be Left-hand and Right-hand, top and bottom, back and front, etc. which ship together in the confines of the same container. The Delphi part numbers have a maximum length of eighteen (18) alphanumeric characters each.

The human readable part numbers characters SHALL be bold and a minimum 3 LPB high\*.

#### **H.4.2 Top Block Right - Quantity**

The maximum length for the quantity is six (6) numeric characters. The human readable quantity characters SHALL be bold and a minimum of 4 LPB high. The printed unit of measure SHALL be SETS. The bar code for the quantity SHALL be directly above the human readable characters, SHALL be a minimum of 2 LBP high, and SHALL contain the data identifier (Q). The field data SHALL not start with zero (0) in the human readable nor should the data following the data identifier in the bar code be zero. This is quantity of sets, not the total of both parts.

#### **H.4.3 2<sup>nd</sup> Block Left - Supplier**

Supplier Ship from DUNS number field as provided by Delphi. The bar code field has a maximum length of twelve (12) alphanumeric characters + Data Identifier of “V”. The human readable characters SHALL appear above the bar code and be bold and a minimum 2 LPB high. The title and data identifier symbol for the Supplier Ship from Duns number field SHALL be directly to the left of the human readable characters.

#### **H.4.4 2<sup>nd</sup> Block Right - DLOC**

The DLOC information indicates Delivery Location where the material will be stored internally at a Delphi division. The maximum length is limited to 8 characters. The text of DLOC SHALL be bold and a minimum 3 LPB high. The data comes from the EDI PCI 11Z segment.

#### **H.4.5 3<sup>rd</sup> Block Left - Serial Number**

Each shipping container or pack SHALL have a unique number called a serial number. This number is assigned by the supplier, not Delphi, and does not necessarily need to be in sequential order. This unique number helps link the bar code data on the labels to EDI for trace-ability. The serial number SHALL NOT be repeated to Delphi on another label within a twelve-month period. The serial number has a maximum length of nine (9) alphanumeric characters + Data Identifier (5S). The human readable serial number characters SHALL be bold and a minimum 2 LPB high. The bar code symbol for the serial number SHALL be directly below the human readable characters, SHALL be a minimum of 2 LBP high.

---

## **H.4.6 3<sup>rd</sup> Block Right - PLT/DOCK**

Line1: It indicates Plant and Dock designation. The data SHALL be bold and a minimum 2 LPB high, with a maximum length of 7 characters. The data comes from the EDI LOC+11 segment.

Lines 2-4 SHALL be used by EDI Certified suppliers. Data will vary by division. Suppliers not EDI certified should try to populate this data as accurately as possible. A heading on each used line denoting what is represented in the data element SHALL be used and SHALL be a minimum of 7 LPB in size and not more than twelve (12) characters in length. The last character of the heading should be a colon (:).

Line2: If used, the data SHALL be a minimum of 5 LPB high, with a maximum length of thirty (30) characters. The data comes from the EDI PCI 13Z segment and its title SHALL be STORAGE BIN:.

Line3: If used, the data SHALL be a minimum of 5 LPB high, with a maximum length of thirty (30) characters. The data comes from the EDI PCI 14Z segment and its title SHALL be PLANT NAME:.

Line4: If used, the data SHALL be a minimum of 5 LPB high, with a maximum length of thirty (30) characters. The data comes from the EDI PCI 15Z segment and its title SHALL be PLANT CITY:.

## **H.4.7 4<sup>th</sup> Block Left - Part description area**

Part description fields have a maximum length of 60 characters for each part, and SHALL be bold and a minimum 6 LPB high. The titles SHALL be "DESCRIPTION PART #1" and "DESCRIPTION PART #2" at a minimum of 6 LPB.

## **H.4.8 4<sup>th</sup> Block Right - Supplier information block**

Contains: Ship Date, Supplier Name, Supplier City, State, Zip, and Country of Origin

Ship Date SHALL be the date the material ships from the supplier's location and SHALL be a minimum of 5 LPB, and in the format MM/DD/YYYY. It SHALL also be preceded by the heading "SHIP DATE:" at a minimum of 6 LPB. Supplier Name SHALL be minimum of 4 LPB high, with a maximum length of thirty six (36) characters. Supplier Street SHALL be minimum of 5 LPB high, with a maximum length of thirty five (35) characters. Supplier City, State and zip code SHALL share one line and be minimum of 5 LPB high, with a maximum length of thirty five (35) characters. Country of Origin SHALL have the title "ASSEMBLED IN or MADE IN" and be a minimum of 5 LPB high, with a maximum length of thirty five (35) characters.

# I. Sub-Pack labeling

## I.1 Sub-Pack Label – General information

This label application applies when material is packaged in small packages (sub-packs) with a single pack carton that is intended to be used/consumed during the manufacturing process.

For placement on various types of containers, labels SHOULD be applied in an easily accessible location and in such manner to facilitate the ability to scan the bar codes on the label.

The supplier SHOULD use code 39 symbology for the bar coded fields. In the event the area on the sub-pack is not large enough to support code 39 then code 128 SHALL be used. UCC/EAN Retail Application sub set SHALL NOT be used. In either case the data identifiers and human readable interpretation of the bar code SHALL follow this specification.

## I.2 Sub-Pack label size and material

The label SHALL be white in color with black printing.

The size of the label SHALL be determined by a combination of the package size it is intended for and the printing technology used. The supplier SHALL work with its customer base to determine what works best for both parties. Label stocks come in a variety of standard small sizes and the supplier SHALL work with their respective media provider to obtain the media best suited for the application.

## I.3 Sub-Pack label data requirements

**Required bar coded fields are as follows:**

Field data	Field title	Data Identifier	Max field length
Delphi Part number	CUST PART (1P)	1P	18
Quantity	QUANTITY (Q)	Q	6
Lot Number	SUPPLIER LOT (1T)	1T	10
Revision level	REV. LEVEL.	2P	3

**Optional fields as determined by Delphi division:**

Part Description	DESCRIPTION	30
Supplier name	SUPPLIER	36

## I.4 Sub-Pack label sample

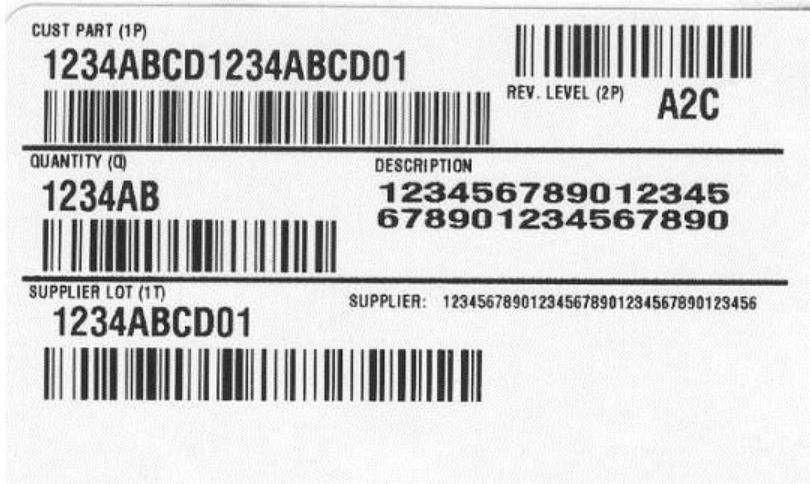

## I.5 Sub-Pack label placement

\* Note: Each individual plant as needed may dictate additional labeling requirements.

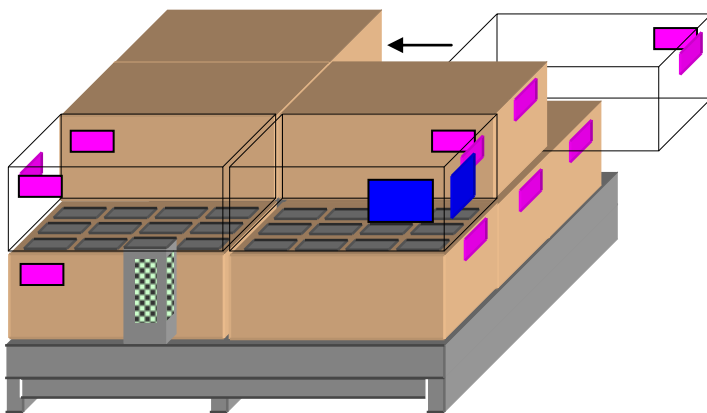
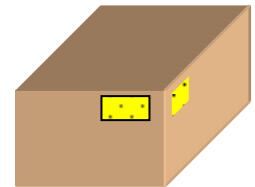
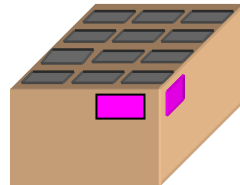
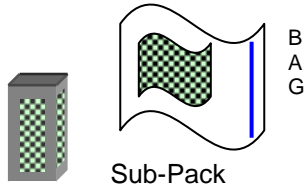

Label Type Color Key	
	Sub-Pack Label
	Container Label
	Master Label
	Mixed Load Label
	Dual Part Label

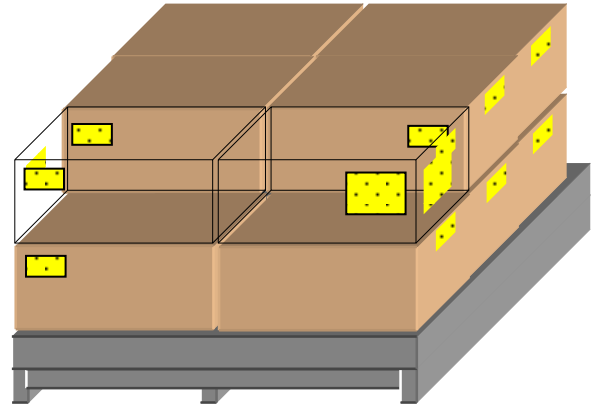
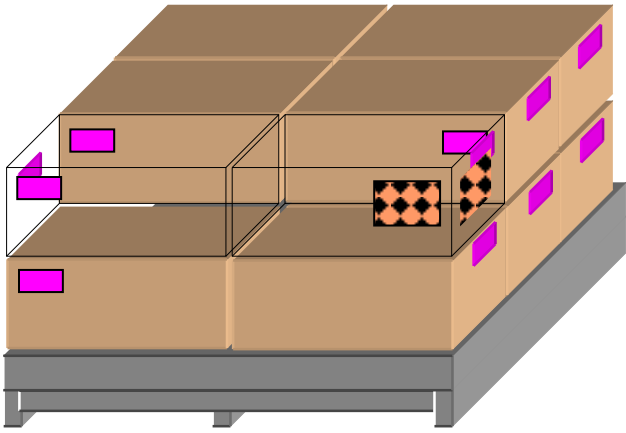



## J. Placement

Labels SHALL be placed no closer than 1.25 inches (32mm) from any container edge. Label placement toward the center of the sides of rectangular, corrugated containers SHOULD be avoided because excessive abrasion damage may result during transportation and render the label not usable.

For placement on various types of containers, labels SHOULD be applied in an easily accessible location\*.

For unit loads, the placement of the label SHALL be on the upper half of the unit load. The bottom edge of the label SHALL NOT be higher than 60 inches (152cm) from the bottom of the unit load.

Unit loads SHALL have identical labels on two adjacent or opposite sides to reduce the destruction of both labels in the event of mishap.

NOTE: Additional labeling requirements may be dictated by each individual plant as needed.

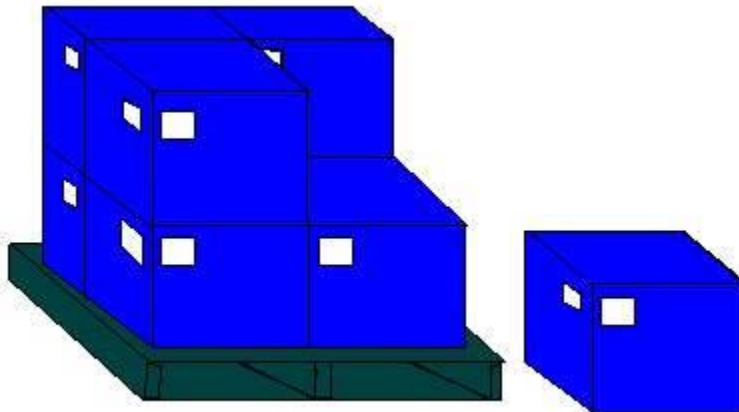

**Figure 9: Example of possible label locations on a palletized box.**

## K. Quality Check

Suppliers have a responsibility to provide bar coded labels that meeting Delphi standards and Delphi has a responsibility to alert suppliers of any persistent label non-conformance.

The ANSI X3.182, Bar Code Print Quality Guideline SHALL be used to determine bar code symbol print quality. It is suggested that the supplier's minimum internal print quality grade SHALL be (B) 3.0/10/660, to guarantee a customer print quality grade of (C) 1.5/10/660 where:

- Minimum print quality grade = 3.0 (B)
- Measurement aperture = 0.010 inch (0.254 mm)
- Inspection wavelength = 660 nanometers +/- 10 nanometers.

**Verification audits shall be used in conjunction with statistical process control to assure label quality.**

## **L. Packing List minimum requirements**

Delphi will not dictate the exact format of the Packing list, it does have some basic data requirements that SHALL appear on the document. The packing list SHALL contain a bar code field for the Advanced Shipment Notice number or ASN. This number is assigned by the supplier and does not necessarily need to be in sequential order. This unique number helps link the bar code data on the labels to EDI for receiving purposes. The ASN number SHALL NOT be repeated to Delphi within a twelve-month period.

### **L.1 Sample Packing Slip Approval**

Your sample packing list SHALL be submitted at the same time your shipping containers labels are sent for approval.

### **L.2 Bar Code symbology for Advanced Shipment Notice or ASN.**

Code 128 SHALL be used with no check digits. The same rules for the bar code fields on the shipping container labels SHALL also apply to the ASN bar code field on the packing list. Adequate quiet zones before and after are required. The data identifier of 2S SHALL be used in the bar code field and SHALL NOT appear as part of the human readable field. The human readable ASN SHALL NOT be less than 0.25 inches in height and SHALL appear below the bar code. The bar code field SHALL have a title of ASN (2S). Each packing list SHALL have a unique ASN. The bar code field SHALL appear in the upper right portion of the document.

The SID (Shipment ID) Number SHALL be the exact same number as sent in the ASN 856 or DESADV Transaction. As the ASN data is transmitted via EDI, suppliers are strongly encouraged to become EDI certified. Please reference the Delphi Electronic Data Interchange (EDI) Requirements Standard.

### **L.3 Other data requirements**

Complete Delphi Address including receiving dock information.

Complete Supplier Address including phone number and contact persons name.

Each part and its quantity on the shipment.

# Appendix

## Appendix A: Label Approval Form

For approval of the shipping label format, fax this form to:

Name: Delphi Labeling Divisional Representative (App. C)

Company

Phone

Fax



Approval Signature: \_\_\_\_\_.

Approval Date: \_\_\_\_\_.

From: Name

Company

Phone

Fax

# Appendix B: Label Approval Checklist by Delphi Internal Usage

Delphi uses an internal database to qualify a label for certification. Each field of the label is tested for the criteria listed. Note this list only displays the criteria for one bar-code field and one non-bar-coded field. Your actual form will contain a block as shown below for each bar-coded field on your particular label format.

## Header information

Supplier Name:	<input type="text"/>	Team Contact & Phone:	<input type="text"/>
Supplier Duns:	<input type="text"/>	Fax Number:	(248)267-8854
Ship to Locations:	<input type="text"/>	Date:	March 27, 2002
Type of Label:	<input type="text" value="Container"/>	Initiative:	<input type="text" value="Shipment"/>
		Analyst Name:	<input type="text"/>

## Field information

### Bar-coded field

1. Part Number	Passed	Comments
Barcode scanable	<input checked="" type="checkbox"/>	<input type="text"/>
Barcode contains identifier	<input checked="" type="checkbox"/>	<input type="text"/>
Barcode matched data	<input checked="" type="checkbox"/>	<input type="text"/>
Barcode height (.5 inches)	<input checked="" type="checkbox"/>	<input type="text"/>
Font size (.4 inches)	<input checked="" type="checkbox"/>	<input type="text"/>
Wide/Narrow Ratio (2.8-3.2)	<input checked="" type="checkbox"/>	<input type="text"/>
Quiet zone	<input checked="" type="checkbox"/>	<input type="text"/>
Other	<input type="checkbox"/>	<input type="text"/>

A check in the Passed block means the item met or exceeded expected minimums.

### Non-Bar-Coded Field

These fields are qualified on the premise of data integrity, font size and positioning. This is denoted by a comment on the form used by Delphi with the heading "Human Readable Text Fields". In the event you have an issue with one of these fields, a copy of the label can be sent depicting the problem along with the above form.

## Appendix C:

Delphi Global Label Contact List by Division: [link to Global Label Contact Spreadsheet Matrix](#). Note: If this link fails to work please contact Jim Courage at [James.Courage@Delphi.com](mailto:James.Courage@Delphi.com).

**Supplier Certification Questions/EDI/General Information?**

**[Link for Delphi Service Desk Information](#)**

## Appendix D: Suggested Label Placement

### ***BASKET, WIRE MESH CONTAINER***

Identical labels **SHALL** be located on two adjacent sides.

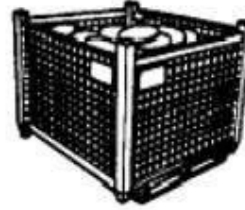

### ***METAL, BIN or TUB***

Tag one visible piece near top or use a label holder.



### ***PALLET BOX***

Identical labels **SHALL** be located on two adjacent sides.

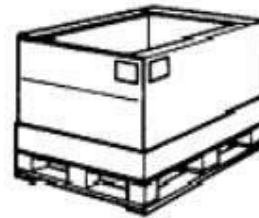

### ***TELESCOPE OR SET- UP CONTAINERS***

Identical labels **SHALL** be located on two adjacent sides of the outer box. Some applications may also require identification of the inner box.

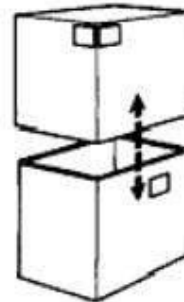

### ***BUNDLE***

Identical tags **SHALL** be located at each end.



***BAG***

Place one label at the center of face.



***ROLL***

Hang one tag 2.0 in (51 mm) from end of material.



***RACK***

Tag one visible piece near top, or use a label holder.

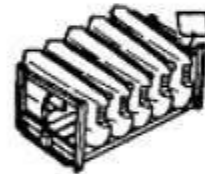

***BOX or CARTON***

Identical labels **SHALL** be located on adjacent sides.

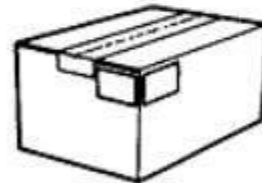

***CARTONS ON PALLET***

Identical Master Load or Mixed Load Labels **SHALL** be used on adjacent sides.

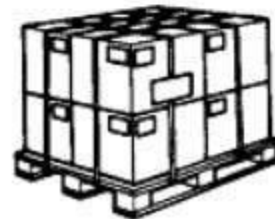



***DRUMS, BARRELS, or  
CYLINDRICAL CONTAINERS***

Identical labels **SHALL** be located on the top and near the center of the side.



***BALES***

Identical labels **SHALL** be located at the upper corner of an end and the adjacent side (wraparound label acceptable).

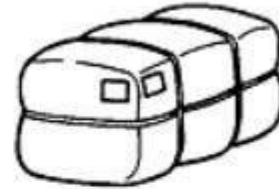

***SINGLE COIL***

Identical labels **SHALL** be used. Locate one on the inside of the coil and one on the outside.

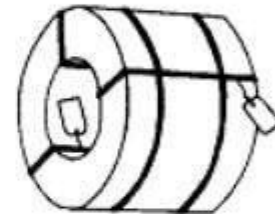

***SLIT COILS***

Identical labels **SHALL** be used. Locate one on the inside of each coil and one on the outside of each coil.

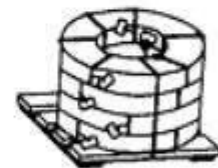

***TUBING and BARS***

Identical labels **SHALL** be used. Attach one to each end of the bundle.



***SHEETS/CUT LENGTHS/BLANKS***

Identical labels **SHALL** be located on two adjacent sides.

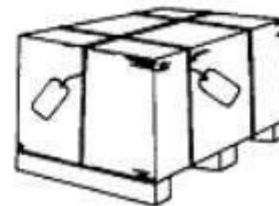

***RETURNABLE CONTAINERS***

Refer to applicable AIAG standards (RC-1 through RC-8).